

BID OF _____

2024

PROPOSAL, CONTRACT, BOND AND SPECIFICATIONS

FOR

2024 SEMI-PERMANENT EPOXY PAVEMENT MARKINGS

CONTRACT NO. 9495

MUNIS NO. 45300

IN

MADISON, DANE COUNTY, WISCONSIN

AWARDED BY THE COMMON COUNCIL
MADISON, WISCONSIN ON _____

CITY ENGINEERING DIVISION
1600 EMIL STREET
MADISON, WISCONSIN 53713

<https://bidexpress.com/login>

**2024 SEMI-PERMANENT EPOXY PAVEMENT MARKINGS
CONTRACT NO. 9495**

INDEX

SECTION A: ADVERTISEMENT FOR BIDS AND INSTRUCTIONS TO BIDDERS A-1

SECTION B: PROPOSAL SECTION B-1

SECTION C: SMALL BUSINESS ENTERPRISE..... C-1

SECTION D: SPECIAL PROVISIONS D-1

SECTION E: BIDDER'S ACKNOWLEDGEMENT E-1

SECTION F: BEST VALUE CONTRACTING..... F-1

SECTION G: BID BOND G-1

SECTION H: AGREEMENT H-1

SECTION I: PAYMENT AND PERFORMANCE BOND..... I-1

This Proposal, and Agreement have
been prepared by:

**CITY ENGINEERING DIVISION
CITY OF MADISON
MADISON, DANE COUNTY, WISCONSIN**

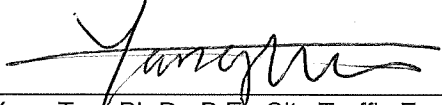

Yang Tao, Ph.D., P.E., City Traffic Engineering

YT: TM

SECTION A: ADVERTISEMENT FOR BIDS AND INSTRUCTIONS TO BIDDERS

REQUEST FOR BID FOR PUBLIC WORKS CONSTRUCTION CITY OF MADISON, WISCONSIN

A BEST VALUE CONTRACTING MUNICIPALITY

PROJECT NAME:	2024 SEMI-PERMANENT EPOXY PAVEMENT MARKINGS
CONTRACT NO.:	9495
SBE GOAL	20%
BID BOND	5%
SBE PRE BID MEETING (2:00 P.M.)	FEBRUARY 1, 2024 (virtual)
PREQUALIFICATION APPLICATION DUE (2:00 P.M.)	FEBRUARY 1, 2024
BID SUBMISSION (2:00 P.M.)	FEBRUARY 8, 2024
BID OPEN (2:30 P.M.)	FEBRUARY 8, 2024
PUBLISHED IN WSJ	JANUARY 25, & FEBRUARY 1, 2024

SBE PRE BID MEETING: Pre-Bid Meetings are being held virtually. Advance registration is required. Visit the SBE Meeting web page on Engineering's web site:

<https://www.cityofmadison.com/engineering/developers-contractors/contractors/how-to-bid-public-works-contracts/small-business>.

Questions regarding SBE Program requirements may be directed to Tracy Lomax, Affirmative Action Division. Tracy may be reached at (608) 267-8634, or by email, TLomax@cityofmadison.com.

PREQUALIFICATION APPLICATION: Forms are available on our website, www.cityofmadison.com/engineering/developers-contractors/contractors/how-to-get-prequalified. If not currently prequalified in the categories listed in Section A, an amendment to your Prequalification will need to be submitted prior to the same due date. Postmark is not applicable.

BIDS TO BE SUBMITTED: by hand to 1600 EMIL ST., MADISON, WI 53713 or online at www.bidexpress.com.

Bids may be submitted on line through Bid Express or in person at 1600 Emil St. The bids will be posted on line after the bid opening. If you have any questions, please call Alane Boutelle at (608) 267-1197, or John Fahrney at (608) 266-9091.

STANDARD SPECIFICATIONS

The City of Madison's Standard Specifications for Public Works Construction - 2024 Edition, as supplemented and amended from time to time, forms a part of these contract documents as if attached hereto.

These standard specifications are available on the City of Madison Public Works website, www.cityofmadison.com/engineering/developers-contractors/standard-specifications.

The Contractor shall review these Specifications prior to preparation of proposals for the work to be done under this contract, with specific attention to Article 102, "BIDDING REQUIREMENTS AND CONDITIONS" and Article 103, "AWARD AND EXECUTION OF THE CONTRACT." For the convenience of the bidder, below are highlights of three subsections of the specifications.

SECTION 102.1: PRE-QUALIFICATION OF BIDDERS

In accordance with Wisconsin State Statutes 66.0901 (2) and (3), all bidders must submit to the Board of Public Works proof of responsibility on forms furnished by the City. The City requires that all bidders be qualified on a biennial basis.

Bidders must present satisfactory evidence that they have been regularly engaged in the type of work specified herein and they are fully prepared with necessary capital, materials, machinery and supervisory personnel to conduct the work to be contracted for to the satisfaction of the City. All bidders must be pre-qualified by the Board of Public Works for the type of construction on which they are bidding prior to the opening of the bid.

In accordance with Section 39.02(9)(a)l. of the General Ordinances, all bidders shall submit in writing to the Affirmative Action Division Manager of the City of Madison, a Certificate of Compliance or an Affirmative Action Plan at the same time or prior to the submission of the proof of responsibility forms.

The bidder shall be disqualified if the bidder fails to or refuses to, prior to opening of the bid, submit a Certificate of compliance, Affirmative Action Plan or Affirmative Action Data Update, as applicable, as defined by Section 39.02 of the General Ordinances (entitled Affirmative Action) and as required by Section 102.11 of the Standard Specifications.

SECTION 102.4 PROPOSAL

No bid will be accepted that does not contain an adequate or reasonable price for each and every item named in the Schedule of Unit Prices.

A lump sum bid for the work in accordance with the plans and specifications is required. The lump sum bid must be the same as the total amounts bid for the various items and it shall be inserted in the space provided.

All papers bound with or attached to the proposal form are considered a part thereof and must not be detached or altered when the proposal is submitted. The plans, specifications and other documents designated in the proposal form will be considered a part of the proposal whether attached or not.

A proposal submitted by an individual shall be signed by the bidder or by a duly authorized agent. A proposal submitted by a partnership shall be signed by a member/partner or by a duly authorized agent thereof. A proposal submitted by a corporation shall be signed by an authorized officer or duly authorized registered agent of such corporation, and the proposal shall show the name of the State under the laws of which such corporation was chartered. The required signatures shall in all cases appear in the space provided thereof on the proposal.

Each proposal shall be placed, together with the proposal guaranty, in a sealed envelope, so marked as to indicate name of project, the contract number or option to which it applies, and the name and address of the Contractor or submitted electronically through Bid Express (www.bidexpress.com). Proposals will be accepted at the location, the time and the date designated in the advertisement. Proposals received after the time and date designated will be returned to the bidder unopened.

SECTION 102.5: BID DEPOSIT (PROPOSAL GUARANTY)

All bids, sealed or electronic, must be accompanied with a Bid Bond (City of Madison form) equal to at least 5% of the bid or a Certificate of Annual/Biennial Bid Bond or certified check, payable to the City Treasurer. Bid deposit of the successful bidders shall be returned within forty-eight (48) hours following execution of the contract and bond as required.

MINOR DISCREPENCIES

Bidder is responsible for submitting all forms necessary for the City to determine compliance with State and City bidding requirements. Notwithstanding any language to the contrary contained herein, the City may exercise its discretion to allow bidders to correct or supplement submissions after bid opening, if the minor discrepancy, bid irregularity or omission is insignificant and not one related to price, quality, quantity, time of completion or performance of the contract.

Bidders for this Contract(s) must be Pre-Qualified for at least one of the following type(s) of construction denoted by an

Building Demolition

- 101 Asbestos Removal
- 120 House Mover

- 110 Building Demolition

Street, Utility and Site Construction

- 201 Asphalt Paving
- 205 Blasting
- 210 Boring/Pipe Jacking
- 215 Concrete Paving
- 220 Con. Sidewalk/Curb & Gutter/Misc. Flat Work
- 221 Concrete Bases and Other Concrete Work
- 222 Concrete Removal
- 225 Dredging
- 230 Fencing
- 235 Fiber Optic Cable/Conduit Installation
- 240 Grading and Earthwork
- 241 Horizontal Saw Cutting of Sidewalk
- 242 Hydro Excavating
- 243 Infrared Seamless Patching
- 245 Landscaping, Maintenance
- 246 Ecological Restoration
- 250 Landscaping, Site and Street
- 251 Parking Ramp Maintenance
- 252 Pavement Marking
- 255 Pavement Sealcoating and Crack Sealing
- 260 Petroleum Above/Below Ground Storage Tank Removal/Installation
- 262 Playground Installer

- 265 Retaining Walls, Precast Modular Units
- 270 Retaining Walls, Reinforced Concrete
- 275 Sanitary, Storm Sewer and Water Main Construction
- 276 Sawcutting
- 280 Sewer Lateral Drain Cleaning/Internal TV Insp.
- 285 Sewer Lining
- 290 Sewer Pipe Bursting
- 295 Soil Borings
- 300 Soil Nailing
- 305 Storm & Sanitary Sewer Laterals & Water Svc.
- 310 Street Construction
- 315 Street Lighting
- 318 Tennis Court Resurfacing
- 320 Traffic Signals
- 325 Traffic Signing & Marking
- 332 Tree pruning/removal
- 333 Tree, pesticide treatment of
- 335 Trucking
- 340 Utility Transmission Lines including Natural Gas, Electrical & Communications
- 399 Other _____

Bridge Construction

- 501 Bridge Construction and/or Repair

Building Construction

- 401 Floor Covering (including carpet, ceramic tile installation, rubber, VCT)
- 402 Building Automation Systems
- 403 Concrete
- 404 Doors and Windows
- 405 Electrical - Power, Lighting & Communications
- 410 Elevator - Lifts
- 412 Fire Suppression
- 413 Furnishings - Furniture and Window Treatments
- 415 General Building Construction, Equal or Less than \$250,000
- 420 General Building Construction, \$250,000 to \$1,500,000
- 425 General Building Construction, Over \$1,500,000
- 428 Glass and/or Glazing
- 429 Hazardous Material Removal
- 430 Heating, Ventilating and Air Conditioning (HVAC)
- 433 Insulation - Thermal
- 435 Masonry/Tuck pointing

- 437 Metals
- 440 Painting and Wallcovering
- 445 Plumbing
- 450 Pump Repair
- 455 Pump Systems
- 460 Roofing and Moisture Protection
- 464 Tower Crane Operator
- 461 Solar Photovoltaic/Hot Water Systems
- 465 Soil/Groundwater Remediation
- 466 Warning Sirens
- 470 Water Supply Elevated Tanks
- 475 Water Supply Wells
- 480 Wood, Plastics & Composites - Structural & Architectural
- 499 Other _____

State of Wisconsin Certifications

- 1 Class 5 Blaster - Blasting Operations and Activities 2500 feet and closer to inhabited buildings for quarries, open pits and road cuts.
- 2 Class 6 Blaster - Blasting Operations and Activities 2500 feet and closer to inhabited buildings for trenches, site excavations, basements, underwater demolition, underground excavations, or structures 15 feet or less in height.
- 3 Class 7 Blaster - Blasting Operations and Activities for structures greater than 15' in height, bridges, towers, and any of the objects or purposes listed as "Class 5 Blaster or Class 6 Blaster".
- 4 Petroleum Above/Below Ground Storage Tank Removal and Installation (Attach copies of State Certifications.)
- 5 Hazardous Material Removal (Contractor to be certified for asbestos and lead abatement per the Wisconsin Department of Health Services, Asbestos and Lead Section (A&LS).) See the following link for application: www.dhs.wisconsin.gov/Asbestos/Cert. State of Wisconsin Performance of Asbestos Abatement Certificate must be attached.
- 6 Certification number as a Certified Arborist or Certified Tree Worker as administered by the International Society of Arboriculture
- 7 Pesticide application (Certification for Commercial Applicator For Hire with the certification in the category of turf and landscape (3.0) and possess a current license issued by the DATCP)
- 8 State of Wisconsin Master Plumbers License.

SECTION B: PROPOSAL

Please refer to the
Bid Express Website
at <https://bidexpress.com>
look up contract number
and go to
Section B: Proposal Page

You can access all City of Madison bid solicitations for FREE at www.bidexpress.com

Click on the “Register for Free” button and follow the instructions to register your company and yourself. You will be asked for a payment subscription preference, since you may wish to bid online someday. Simply choose the method to pay on a ‘per bid’ basis. This requires no payment until / unless you actually bid online. You can also choose the monthly subscription plan at this time. You will, however, be asked to provide payment information. Remember, you can change your preference at anytime. You will then be able to complete your free registration and have full access to the site. Your free access does not require completion of the ‘Digital ID’ process, so you will have instant access for viewing and downloading. To be prepared in case you ever do wish to bid online, you may wish to establish your digital ID also, since you cannot bid without a Digital ID.

If you have any problems with the free registration process, you can call the bidexpress help team, toll free at 1-888-352-2439 (option 1, option1).

SECTION C: SMALL BUSINESS ENTERPRISE

Instructions to Bidders City of Madison SBE Program Information

2 Small Business Enterprise (SBE) Program Information

2.1 Policy and Goal

The City of Madison reaffirms its policy of nondiscrimination in the conduct of City business by maintaining a procurement process which remains open to all who have the potential and ability to sell goods and services to the City. It is the policy of the City of Madison to allow Small Business Enterprises (SBE) maximum feasible opportunity to participate in City of Madison contracting. The bidder acknowledges that its bid has been submitted in accordance with the SBE program and is for the public's protection and welfare.

Please refer to the "ADVERTISEMENT FOR BIDS" for the goal for the utilization of SBEs on this project. SBEs may participate as subcontractors, vendors and/or suppliers, which provide a commercially useful function. The dollar value for SBE suppliers or 'materials only' vendors shall be discounted to 60% for purposes of meeting SBE goals.

A bidder which achieves or exceeds the SBE goal will be in compliance with the SBE requirements of this project. In the event that the bidder is unable to achieve the SBE goal, the bidder must demonstrate that a good faith effort to do so was made. Failure to either achieve the goal or demonstrate a good faith effort to do so will be grounds for the bidder being deemed a non-responsible contractor ineligible for award of this contract.

A bidder may count towards its attainment of the SBE goal only those expenditures to SBEs that perform a commercially useful function. For purposes of evaluating a bidder's responsiveness to the attainment of the SBE goal, the contract participation by an SBE is based on the percentage of the total base bid proposed by the Contractor. The total base bid price is inclusive of all addenda.

Work performed by an SBE firm in a particular transaction can be counted toward the goal only if it involves a commercially useful function. That is, in light of industry practices and other relevant considerations, does the SBE firm have a necessary and useful role in the transaction, of a kind for which there is a market outside the context of the SBE Program, or is the firm's role a superfluous step added in an attempt to obtain credit towards goals? If, in the judgment of the Affirmative Action Division, the SBE firm will not perform a commercially useful function in the transaction, no credit towards goals will be awarded.

The question of whether a firm is performing a commercially useful function is completely separate from the question of whether the firm is an eligible SBE. A firm is eligible if it meets the definitional criteria and ownership and control requirements, as set forth in the City of Madison's SBE Program.

If the City of Madison determines that the SBE firm is performing a commercially useful function, then the City of Madison must then decide what that function is. If the commercially useful function is that of an SBE vendor / supplier that regularly transacts business with the respective product, then the City of Madison will count 60% of the value of the product supplied toward SBE goals.

To be counted, the SBE vendor / supplier must be engaged in selling the product in question to the public. This is important in distinguishing an SBE vendor / supplier, which has a regular trade with a variety of customers, from a firm which performs supplier-like functions on an ad hoc basis or for only one or two contractors with whom it has a special relationship.

A supplier of bulk goods may qualify as an eligible SBE vendor / supplier if it either maintains an inventory or owns or operates distribution equipment. With respect to the distribution equipment; e.g., a fleet of trucks, the term "operates" is intended to cover a situation in which the supplier leases the equipment on a regular basis for its entire business. It is not intended to cover a situation in which the firm simply provides drivers for trucks owned or leased by another party; e.g., a prime contractor, or leases such a party's trucks on an ad hoc basis for a specific job.

If the commercially useful function being performed is not that of a qualified SBE vendor / supplier, but rather that of delivery of products, obtaining bonding or insurance, procurement of personnel, acting as a broker or manufacturer's representative in the procurement of supplies, facilities, or materials, etc., only the fees or commissions will apply towards the goal.

For example, a business that simply transfers title of a product from manufacturer to ultimate purchaser; e. g., a sales representative who re-invoices a steel product from the steel company to the Contractor, or a firm that puts a product into a container for delivery would not be considered a qualified SBE vendor / supplier. The Contractor would not receive credit based on a percentage of the cost of the product for working with such firms.

Concerning the use of services that help the Contractor obtain needed supplies, personnel, materials or equipment to perform a contract: only the fee received by the service provider will be counted toward the goal. For example, use of a SBE sales representative or distributor for a steel company, if performing a commercially useful function at all, would entitle the Contractor receiving the steel to count only the fee paid to the representative or distributor toward the goal. This provision would also govern fees for professional and other services obtained expressly and solely to perform work relating to a specific contract.

Concerning transportation or delivery services: if an SBE trucking company picks up a product from a manufacturer or a qualified vendor / supplier and delivers the product to the Contractor, the commercially useful function it is performing is not that of a supplier, but simply that of a transporter of goods. Unless the trucking company is itself the manufacturer or a qualified vendor / supplier in the product, credit cannot be given based on a percentage of the cost of the product. Rather, credit would be allowed for the cost of the transportation service.

The City is aware that the rule's language does not explicitly mention every kind of business that may contribute work on this project. In administering these programs, the City would, on a case-by-case basis, determine the appropriate counting formula to apply in a particular situation.

2.2 Contract Compliance

Questions concerning the SBE Program shall be directed to the Contract Compliance Officer of the City of Madison Department of Civil Rights, Affirmative Action Division, 210 Martin Luther King, Jr. Blvd., Room 523, Madison, WI 53703; telephone (608) 266-4910.

2.3 Certification of SBE by City of Madison

The Affirmative Action Division maintains a directory of SBEs which are currently certified as such by the City of Madison. Contact the Contract Compliance Officer as indicated in Section 2.2 to receive a copy of the SBE Directory or you may access the SBE Directory online at www.cityofmadison.com/civil-rights/contract-compliance/targeted-business-enterprise-programs/targeted-business-enterprise.

All contractors, subcontractors, vendors and suppliers seeking SBE status must complete and submit the **Targeted Business Certification Application** to the City of Madison Affirmative Action Division by the time and date established for receipt of bids. A copy of the Targeted Business Certification Application is available by contacting the Contract Compliance Officer at the address and telephone indicated in Section 2.2 or you may access the Targeted Business Certification Application online at www.cityofmadison.com/civil-rights/contract-compliance/targeted-business-enterprise-programs/targeted-business-enterprise. Submittal of the Targeted Business Certification Application by the time specified does not guarantee that the applicant will be certified as a SBE eligible to be utilized towards meeting the SBE goal for this project.

2.4 Small Business Enterprise Compliance Report

2.4.1 Good Faith Efforts

Bidders shall take all necessary affirmative steps to assure that SBEs are utilized when possible and that the established SBE goal for this project is achieved. A contractor who self performs a portion of the work, and is pre-qualified to perform that category of work, may subcontract that portion of the work, but shall not be required to do so. When a bidder is unable to achieve the established SBE goal, the bidder must demonstrate that a good faith effort to do so was made. Such a good faith effort should include the following:

- 2.4.1.1 Attendance at the pre-bid meeting.
- 2.4.1.2 Using the City of Madison's directory of certified SBEs to identify SBEs from which to solicit bids.
- 2.4.1.3 Assuring that SBEs are solicited whenever they are potential sources.
- 2.4.1.4 Referring prospective SBEs to the City of Madison Affirmative Action Division for certification.
- 2.4.1.5 Dividing total project requirements into smaller tasks and/or quantities, where economically feasible, to permit maximum feasible SBE participation.
- 2.4.1.6 Establishing delivery schedules, where requirements permit, which will encourage participation by SBEs.
- 2.4.1.7 Providing SBEs with specific information regarding the work to be performed.
- 2.4.1.8 Contacting SBEs in advance of the deadline to allow such businesses sufficient time to prepare a bid.
- 2.4.1.9 Utilizing the bid of a qualified and competent SBE when the bid of such a business is deemed reasonable (i.e. 5% above the lowest bidder), although not necessarily low.
- 2.4.1.10 Contacting SBEs which submit a bid, to inquire about the details of the bid and confirm that the scope of the work was interpreted as intended.
- 2.4.1.11 Completion of Cover Page (page C-6), Summary Sheet (page C-7) and SBE Contact Reports (pages C-8 and C9) if applicable.

2.4.2 Reporting SBE Utilization and Good Faith Efforts

The Small Business Enterprise Compliance Report is to be submitted by the bidder with the bid: This report is due by the specified bid closing time and date. Bids submitted without a completed SBE Compliance Report as outlined below may be deemed non-responsible and the bidder ineligible for award of this contract. Notwithstanding any language to the contrary contained herein, the City may exercise its discretion to allow bidders to correct or supplement submissions after bid opening, if the minor discrepancy, bid irregularity or omission is insignificant and not one related to price, quality, quantity, time of completion, performance of the contract, or percentage of SBE utilization.

2.4.2.1 If the Bidder meets or exceeds the goal established for SBE utilization, the Small Business Enterprise Compliance Report shall consist of the following:

- 2.4.2.1.1 **Cover Page**, Page C-6; and
- 2.4.2.1.2 **Summary Sheet**, C-7.

2.4.2.2 If the bidder does not meet the goal established for SBE utilization, the Small Business Enterprise Compliance Report shall consist of the following:

- 2.4.2.2.1 **Cover Page**, Page C-6;
- 2.4.2.2.2 **Summary Sheet**, C-7; and
- 2.4.2.2.3 **SBE Contact Report**, C-8 and C-9. (A separate Contact Report must be completed for each applicable SBE which is not utilized.)

2.5 Appeal Procedure

A bidder which does not achieve the established goal and is found non-responsible for failure to demonstrate a good faith effort to achieve such goal and subsequently denied eligibility for award of contract may appeal that decision to the Small Business Enterprises Appeals Committee. All appeals shall be made in writing, and shall be delivered to and received by the City Engineer no later than 4:30 PM on the third business day following the bidder's receipt of the written notification of ineligibility by the Affirmative Action Division Manager. Postmark not acceptable. The notice of appeal shall state the basis for the appeal of the decision of the Affirmative Action Division Manager. The Appeal shall take place in accordance with Madison General Ordinance 33.54.

2.6 SBE Requirements After Award of the Contract

The successful bidder shall identify SBE subcontractors, suppliers and vendors on the subcontractor list in accordance with the specifications. The Contractor shall submit a detailed explanation of any variances between the listing of SBE subcontractors, vendors and/or suppliers on the subcontractor list and the Contractor's SBE Compliance Report for SBE participation.

No change in SBE subcontractors, vendors and/or suppliers from those SBEs indicated in the SBE Compliance Report will be allowed without prior approval from the Engineer and the Affirmative Action Division. The contractor shall submit in writing to the City of Madison Affirmative Action Division a request to change any SBE citing specific reasons which necessitate such a change. The Affirmative Action Division will use a general test of reasonableness in approving or rejecting the contractor's request for change. If the request is approved, the Contractor will make every effort to utilize another SBE if available.

The City will monitor the project to ensure that the actual percentage commitment to SBE firms is carried out.

2.7 SBE Definition and Eligibility Guidelines

A Small Business Enterprise is a business concern awarded certification by the City of Madison. For the purposes of this program a Small Business Enterprise is defined as:

- A. An independent business operated under a single management. The business may not be a subsidiary of any other business and the stock or ownership may not be held by any individual or any business operating in the same or a similar field. In determining whether an entity qualifies as a SBE, the City shall consider all factors relevant to being an independent business including, but not limited to, the date the business was established, adequacy of its resources for the work in which it proposes to involve itself, the degree to which financial, equipment leasing and other relationships exist with other ineligible firms in the same or similar lines of work. SBE owner(s) shall enjoy the customary incidents of ownership and shall share in the risks and profits commensurate with their enjoyment interests, as demonstrated by an examination of the substance rather than form or arrangements that may be reflected in its ownership documents.

- B. A business that has averaged no more than \$4.0 million in annual gross receipts over the prior three year period and the principal owner(s) do not have a personal net worth in excess of \$1.32 million.

Firm and/or individuals that submit fraudulent documents/testimony may be barred from doing business with the City and/or forfeit existing contracts.

SBE certification is valid for one (1) year unless revoked.

**2024 SEMI-PERMANENT EPOXY PAVEMENT MARKINGS
CONTRACT NO. 9495**

Small Business Enterprise Compliance Report

**This information may be submitted electronically through
Bid Express or submitted with bid in sealed envelope.**

Cover Sheet

Prime Bidder Information

Company: _____

Address: _____

Telephone Number: _____ Fax Number: _____

Contact Person/Title: _____

Prime Bidder Certification

I, _____, _____ of
Name Title

_____ certify that the information
Company

contained in this SBE Compliance Report is true and correct to the best of my knowledge and belief.

Witness' Signature

Bidder's Signature

Date

**2024 SEMI-PERMANENT EPOXY PAVEMENT MARKINGS
CONTRACT NO. 9495**

Small Business Enterprise Compliance Report

SBE Contact Report

Submit separate copy of this form for each SBE which you are not able to utilize towards meeting the SBE goal for this project. Attach separate sheets if necessary.

SBE Information

Company: _____

Address: _____

Telephone Number: _____

Contact Person/Title: _____

1. Outline below all efforts to solicit a bid from the above SBE. Include date, means of contact, who from your company made this contact and the result.

2. Describe the information provided to the aforementioned SBE regarding the scope of work for which he/she was to provide a bid.

Is this the same scope of work on which the subcontractor you intend to utilize based his/her bid?

Yes No

3. Did this SBE submit a bid? Yes No

4. Is the General Contractor pre-qualified to self-perform this category of work?

Yes No

5. If you responded "Yes" to Question 3, please check the items below which apply and provide the requested detail. If you responded "No" to Question 3, please skip ahead to item 6 below.

The SBE listed above is unavailable for work on this project for the following reasons. Provide specific detail for this conclusion.

The SBE listed above is unqualified for work on this project. Provide specific details for this conclusion.

The SBE listed above provided a price that was unreasonable (i.e. more than 5% above the lowest bidder). Provide specific detail for this conclusion including the SBE's price and the price of the subcontractor you intend to utilize.

A contract with the SBE listed above may constitute a breach of the bidder's collective bargaining agreements. Provide specific detail for this conclusion including, but not limited to, correspondence from the SBE indicating it will not sign a project labor agreement and/or correspondence from the applicable trade union indicating a project labor agreement will not be allowed at the time of project bidding.

Other; please specify reason(s) other than listed above which made it impossible for you to utilize this SBE on this project.

6. Describe any other good faith efforts:

SECTION D: SPECIAL PROVISIONS

2024 SEMI-PERMANENT EPOXY PAVEMENT MARKINGS CONTRACT NO. 9495

It is the intent of these Special Provisions to set forth the final contractual intent as to the matter involved and shall prevail over the Standard Specifications and plans whenever in conflict therewith. In order that comparisons between the Special Provisions can be readily made, the numbering system for the Special Provisions is equivalent to that of the Specifications.

Whenever in these Specifications the term "Standard Specifications" appears, it shall be taken to refer to the City of Madison Standard Specifications for Public Works Construction and Supplements thereto.

SECTION 102.11: BEST VALUE CONTRACTING

This Contract shall be considered a Best Value Contract if the Contractor's bid is equal to or greater than \$75,500 for a single trade contract; or equal to or greater than \$369,500 for a multi-trade contract pursuant to MGO 33.07(7).

ARTICLE 104 SCOPE OF WORK

This work consists of the furnishing and application or removal of epoxy pavement markings at locations throughout the City of Madison and per City of Madison Standard Pavement Marking Details or as shown on the plans provided by the City Of Madison.

The scheduling of each year's remarking work, with a few exceptions, will be flexible and can be at the contractor's discretion. However, markings on new road surfaces shall be installed within fifteen (15) days of notification to install, which will be scheduled as soon after completion of final paving as practical.

SECTION 105.1: AUTHORITY OF THE ENGINEER

The Engineer shall resolve all questions which arise as to the quality and acceptability of materials furnished, work performed, manner of performance, rate of progress of the work, interpretation of the plans and Specifications, acceptable fulfillment of the contract, compensation, and disputes and mutual rights between Contractors under the Specifications. The Engineer shall determine the amount and quantity of work performed and materials furnished.

All decisions of the Engineer shall, when so requested, be rendered in writing. They shall be final and conclusive in all matters unless within ten (10) days after such decision the Contractor applies in writing to the Board of Public Works for a review of such decision.

Any change proposed by a Contractor in SBE subcontractors, vendors or suppliers from those SBEs indicated on the SBE Compliance Report must be approved by the Engineer and the City's Manager of the Affirmative Action Division (hereafter, AAD). When requested, such decision shall be rendered in writing. Such decisions shall be final and conclusive in all matters unless within ten (10) days after such decision the Contractor or the affected SBE applies in writing to the Board of Public Works for a review of such decision.

In the event the Engineer and the AAD disagree over the proper decision to be made regarding an SBE, the Mayor shall appoint a third person to resolve the disagreement, within 30 days of appointment. The decision thus rendered may be reviewed by the Board of Public Works upon request of the Contractor or the affected SBE as set forth in Sections 105.1 and 105.2 of the City's standard specifications.

SECTION 105.5 INSPECTION OF WORK

Acceptable performance of pavement markings will be evaluated during the proving period in sections. Each edge line, lane line, center line, or barrier line, measured through 600 foot length will be considered

a section. Miscellaneous markings including channelizing lines, groupings of diagonal lines, stop lines, crosswalks, median nose, symbols and words and parking stalls will be evaluated separately as a section.

SECTION 107.7 MAINTENANCE OF TRAFFIC

No work shall be done on this contract between the weekday hours of 7:00 a.m. and 8:30 a.m. and between the hours of 4:00 p.m. and 5:30 p.m. unless authorized in writing by the City Traffic Engineer.

SECTION 109.5 METHODS AND EQUIPMENT

The work shall conform to all aspects of the current edition of Wisconsin Department of Transportation Standard Specifications, Part 6 Section 646 & Section 647 that relate to epoxy pavement markings except for the measurement and payment items described in the following section.

ARTICLE 110 MEASUREMENT AND PAYMENT

Measurement and payment shall be per the current edition of Wisconsin Department of Transportation Standard Specifications, Part 6 Sections 646 & Sections 647 as it relates to the items in this contract except for the measurement and payment items described below.

Measurement and payment of MEDIAN NOSE shall be by the square foot of material applied/removed.

Measurement and payment of 4-INCH DOUBLE YELLOW shall be per linear foot of two(2) 4" lines of material applied/removed.

Measurement and payment of BIKE LANE SYMBOL WITH ARROW shall be per set.

Measurement and payment of PAVEMENT MARKING REMOVAL shall be by **linear foot** and **width** of line or by **each** ARROW, WORD OR SYMBOL.

SECTION 107.4(H): CERTIFICATES OF INSURANCE

Proof of Insurance, Approval. The Contractor shall provide the City with certificate(s) of insurance showing the type, amount, effective dates, and expiration dates of required policies prior to commencing work under this Contract. Contractor shall provide the certificate(s) to the City's representative upon execution of the Contract, or sooner, for approval by the City Risk Manager. If any of the policies required above expire while this Contract is in effect, Contractor shall provide renewal certificate(s) to the City for approval. Certificate Holder language should be listed as follows:

City of Madison
ATTN: Risk Management, Room 406
210 Martin Luther King, Jr. Blvd.
Madison, WI 53703

The Contractor shall provide copies of additional insured endorsements or insurance policies, if requested by the City Risk Manager. The Contractor and/or Insurer shall give the City thirty (30) days advance written notice of cancellation, non-renewal or material changes to any of the above-required policies during the term of this Contract.

PERMANENT PAVEMENT MARKINGS

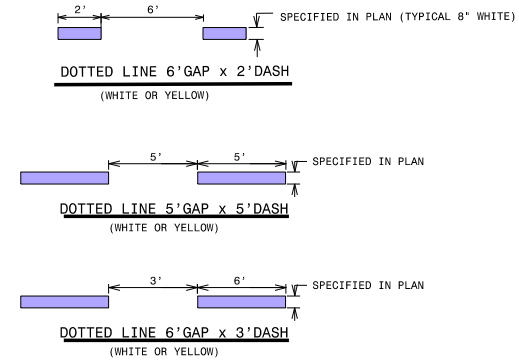
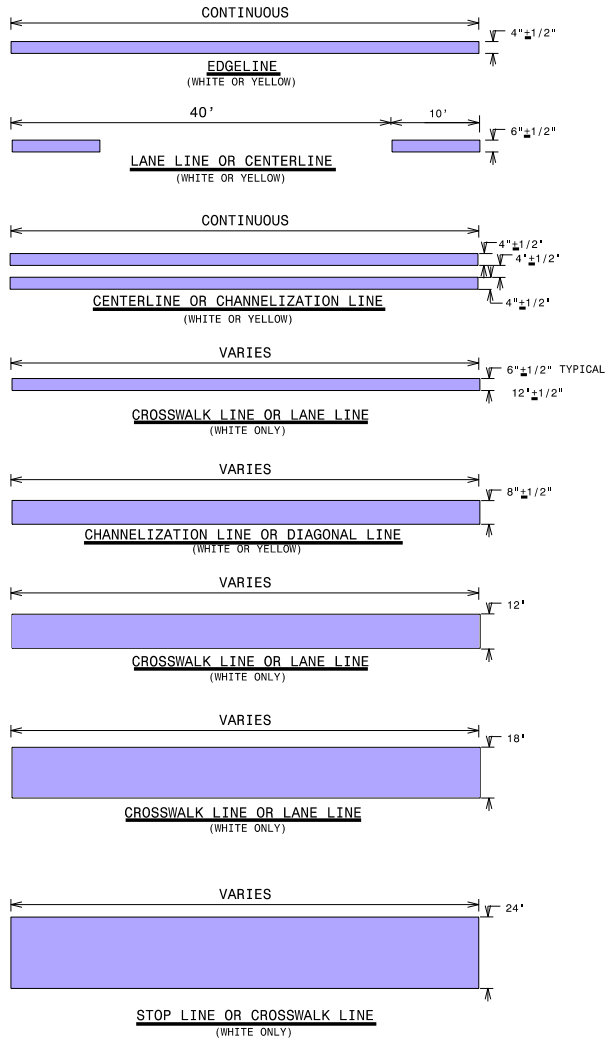

GENERAL NOTES FOR EPOXY PAVEMENT MARKINGS
 THE CONTRACTOR SHALL APPLY ALL MARKINGS IN ACCORDANCE WITH THE STATE OF WISCONSIN MANUAL ON TRAFFIC CONTROL DEVICES.
 AT STREET INTERSECTIONS, MARKINGS START OR END AT THE MARKED CROSSWALK. THE PROPERTY LINE EXTENDED, IF THERE IS NO MARKED CROSSWALK.

CROSSWALKS AND STOP BARS WILL BE PLACED NO CLOSER THAN 2' TO THE FACE OF CURB.
 THE CONTRACTOR SHALL ADHERE TO THE TRAFFIC SPECIFICATION IN THE SPECIAL PROVISIONS AT ALL TIMES.

FOR MORE INFORMATION AND FULL SIZE PATTERNS FOR ARROWS & WORD LEGENDS ARE AVAILABLE AT THE CITY OF MADISON TRAFFIC ENGINEERING FIELD OPERATIONS FACILITY 1120 SAYLE ST. (608) 266-4767

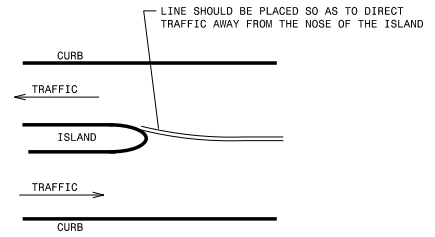
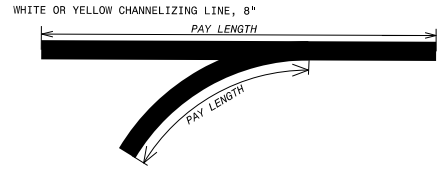

ISLAND APPROACH

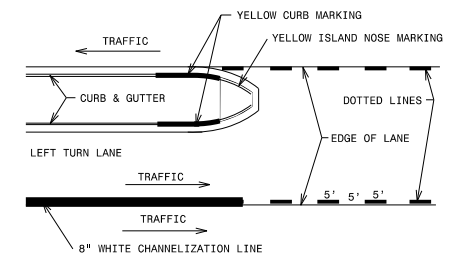
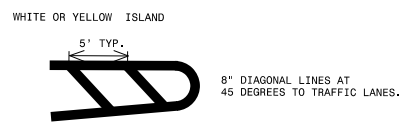

LEFT TURN LANE

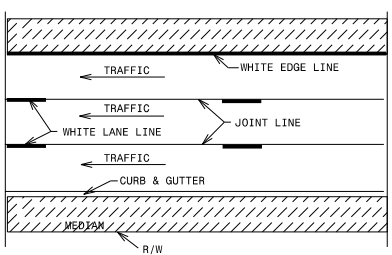

MARKING PLACEMENT DETAIL

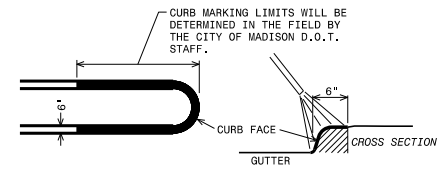
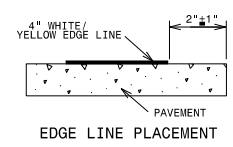

CURB & ISLAND MARKING DETAILS

2009

CITY OF MADISON
 ENGINEERING DIVISION

PAVEMENT MARKING
 DETAILS
 PAGE 1

STANDARD DETAIL DRAWING # 6.37

D-4

SPECIAL CROSSWALKS

SPECIAL CROSSWALKS HAVE TWO(2) 12-INCH WIDE LINES PLACED ACROSS THE TRAFFIC FLOW AND 24-INCH WIDE CROSSBARS IN LINE WITH THE TRAFFIC FLOW.

THE SPACING OR GAP BETWEEN THE CROSSBARS IS DETERMINED IN THE FIELD AND VARIES BETWEEN 24 TO 48 INCHES SO THAT NO CROSSBAR IS PLACED IN THE MAIN WHEEL TRACK AREA.

TYPICALLY, A CROSSBAR IS CENTERED ON THE CENTERLINE. ANOTHER CROSSBAR IS CENTERED BETWEEN THE WHEEL TRACKS AND ANOTHER CROSSBAR PLACED BETWEEN THE OUTSIDE WHEEL TRACK AND THE EDGE OF GUTTER OR PAVEMENT. IN NO CASE SHALL THE CROSSBAR BE PLACED IN OR NEXT TO THE GUTTER SECTION.

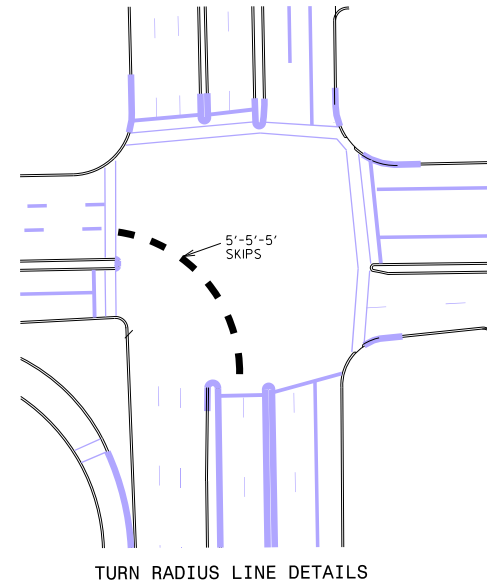
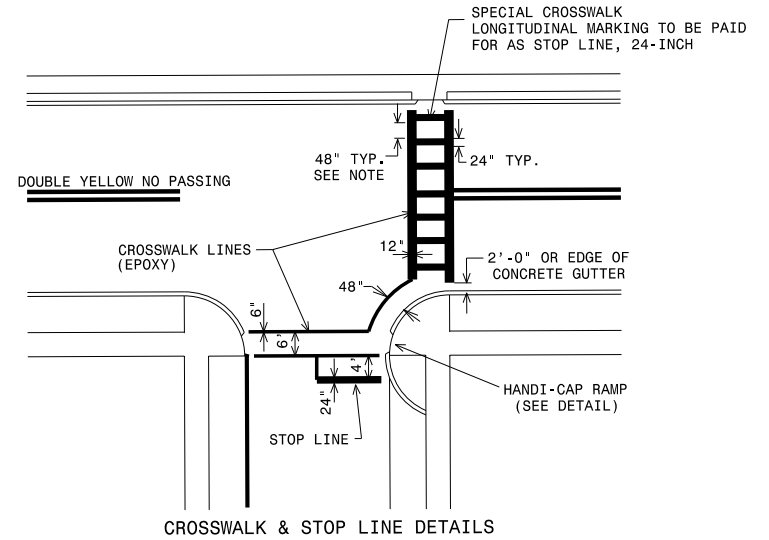

2009

CITY OF MADISON
ENGINEERING DIVISION

PAVEMENT MARKING
DETAILS
PAGE 2

STANDARD DETAIL DRAWING # 6.38

D-5

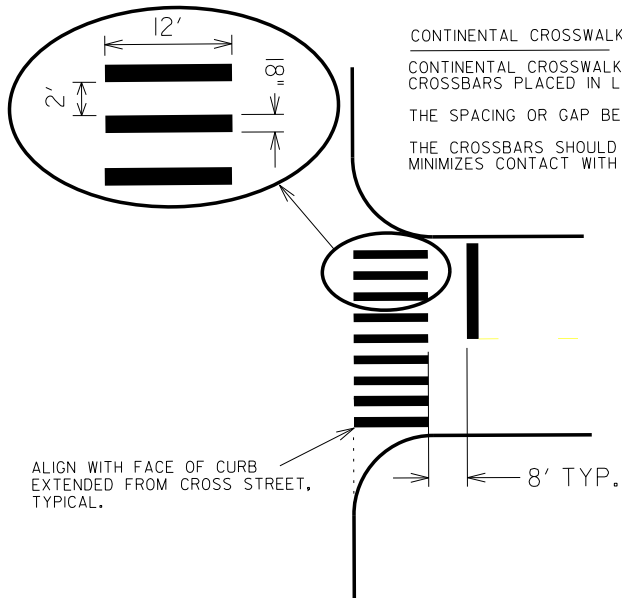

CONTINENTAL CROSSWALKS

CONTINENTAL CROSSWALKS HAVE 18 INCH WIDE 12 FOOT LONG CROSSBARS PLACED IN LINE WITH THE TRAFFIC FLOW.

THE SPACING OR GAP BETWEEN THE CROSSBARS IS 24 INCHES

THE CROSSBARS SHOULD BE PLACED IN A MANNER THAT MINIMIZES CONTACT WITH VEHICLES TIRES.

RESTRICTED TRAFFIC LANE MARKING DETAILS

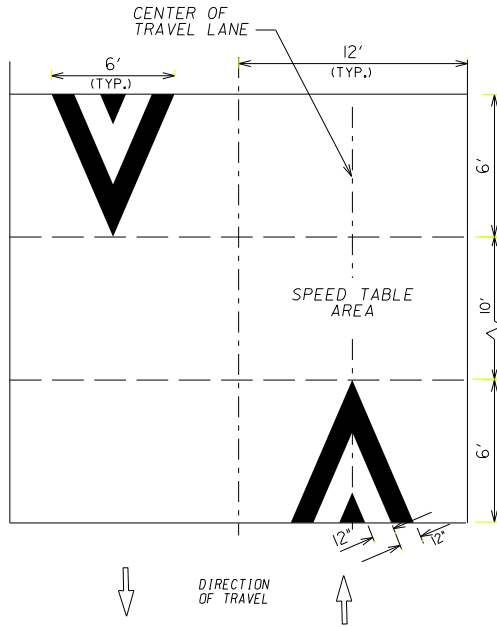

MARKINGS FOR SPEED HUMPS

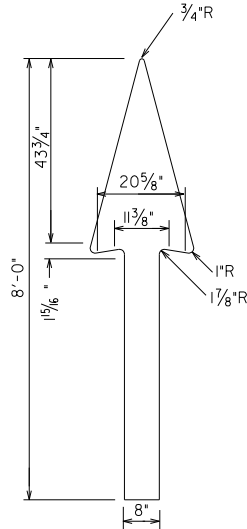

STRAIGHT ARROW

LEFT ARROW'S DIMENSIONS SAME AS SHOWN ON RIGHT ARROW

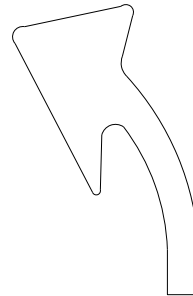

LEFT ARROW

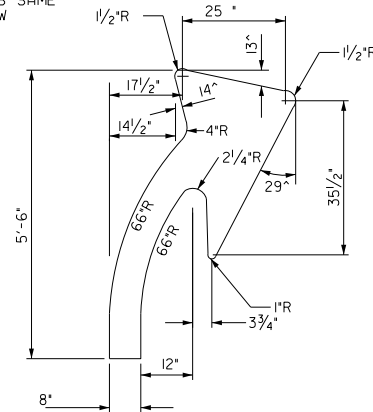

RIGHT ARROW

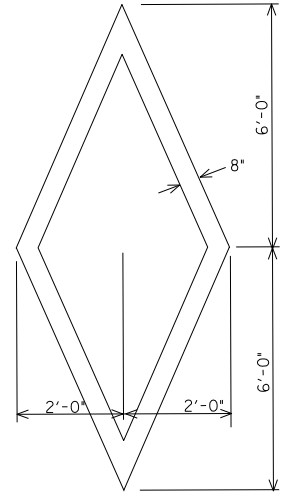

RESTRICTED LANE SYMBOL

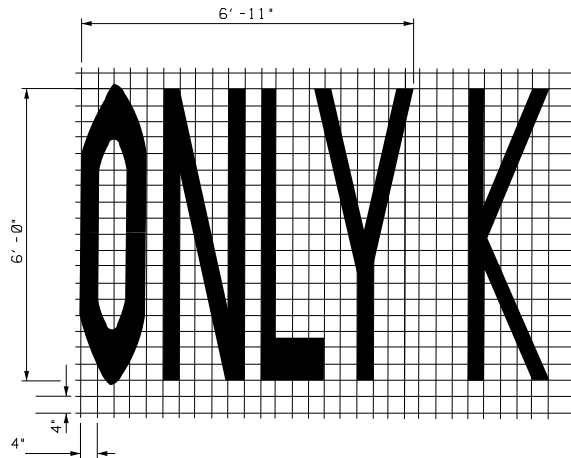

WORD LEGEND

FULL SIZE PATTERNS FOR ARROWS & WORD LEGENDS ARE AVAILABLE AT:
CITY OF MADISON TRAFFIC ENGINEERING
FIELD OPERATIONS FACILITY
1120 SAYLE ST. (608)266-4767

FEB 2005

CITY OF MADISON
ENGINEERING DIVISION

PAVEMENT MARKING
DETAILS
PAGE 3

STANDARD DETAIL DRAWING # 6.39

D-6

BIKE LANE MARKING DETAILS

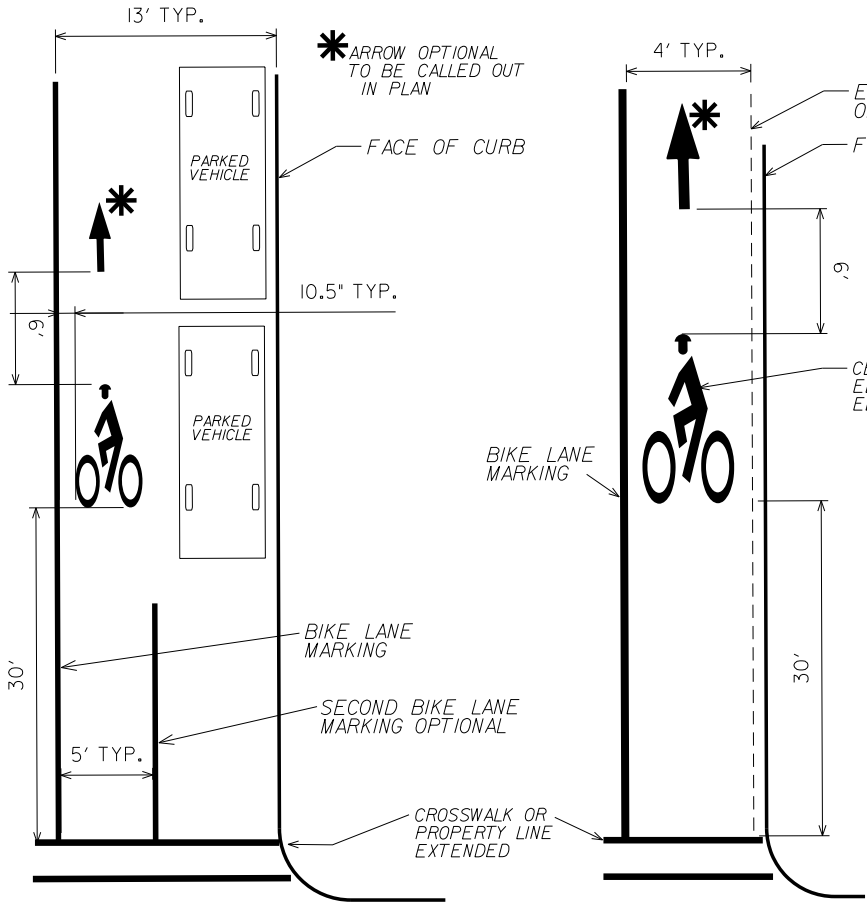

BIKE LANE SYMBOL & OPTIONAL ARROW LAYOUT --WITH PARKING LANE--

BIKE LANE SYMBOL & OPTIONAL ARROW LAYOUT --CURBSIDE--

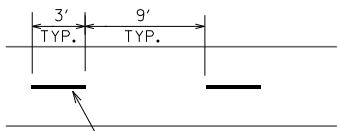

TYPICAL BIKE PATH PAVEMENT MARKINGS

LEFT ARROW'S DIMENSIONS SAME AS SHOWN ON RIGHT ARROW



LEFT ARROW

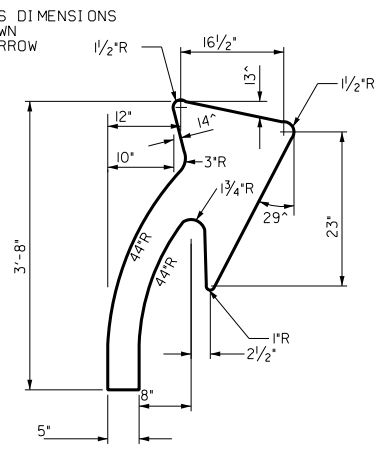

RIGHT ARROW

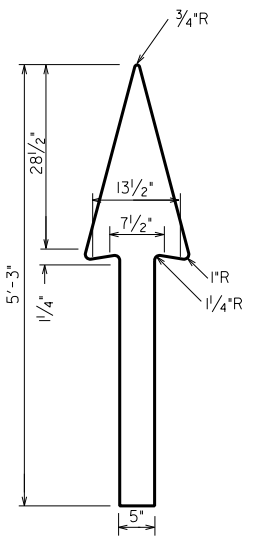

STRAIGHT ARROW

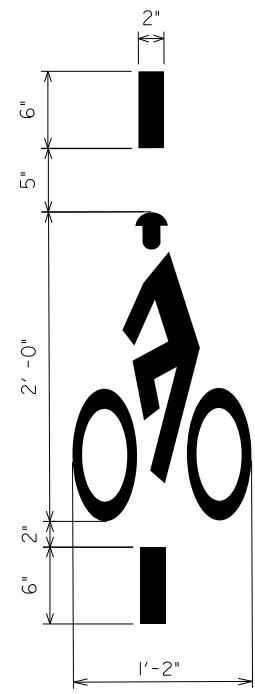

BICYCLE DETECTOR PAVEMENT MARKING

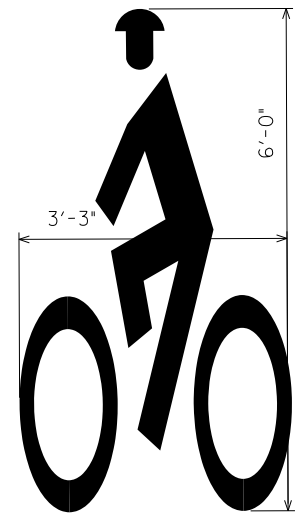

BIKE LANE SYMBOL FACING TRAFFIC LANE

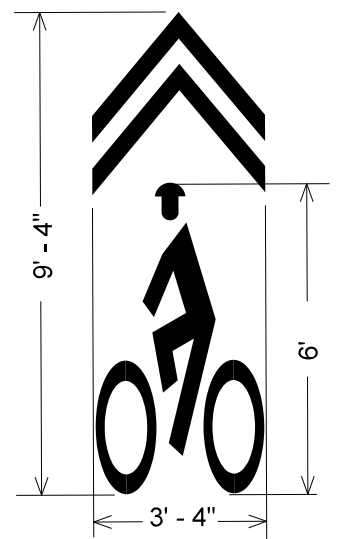

SHARROW DETAIL

FULL SIZE PATTERNS FOR ARROWS & WORD LEGENDS ARE AVAILABLE AT: CITY OF MADISON TRAFFIC ENGINEERING FIELD OPERATIONS FACILITY 1120 SAYLE ST. (608)266-4767

2009

CITY OF MADISON ENGINEERING DIVISION
PAVEMENT MARKING DETAILS PAGE 4
STANDARD DETAIL DRAWING # 6.40

TE STANDARD SHARROW CENTERLINE DETAIL

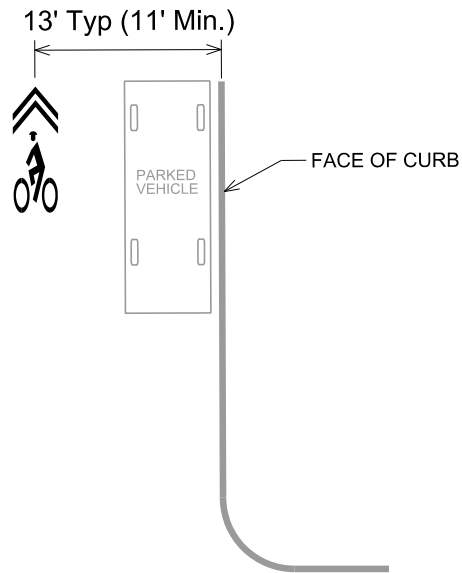

Sharrow Centerline
WITH On Street Parking

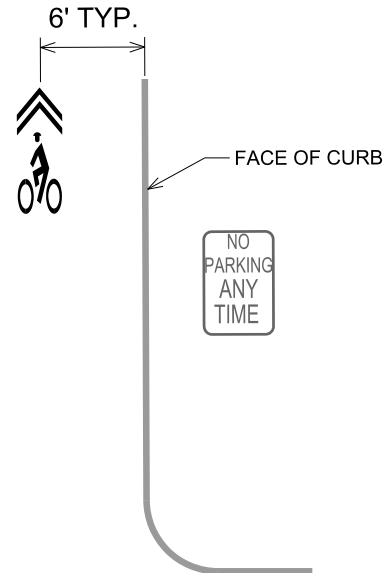

Sharrow Centerline
NO On Street Parking

St Width (face-face)	Sharrow Placement (from face)
22'	11'
24'	12'
$\geq 26'$	13'

CITY OF MADISON
ENGINEERING DIVISION

PAVEMENT MARKINGS
SHARROW BIKE DETAILS
PAGE 4b

STANDARD DETAIL DRAWING # 6.40

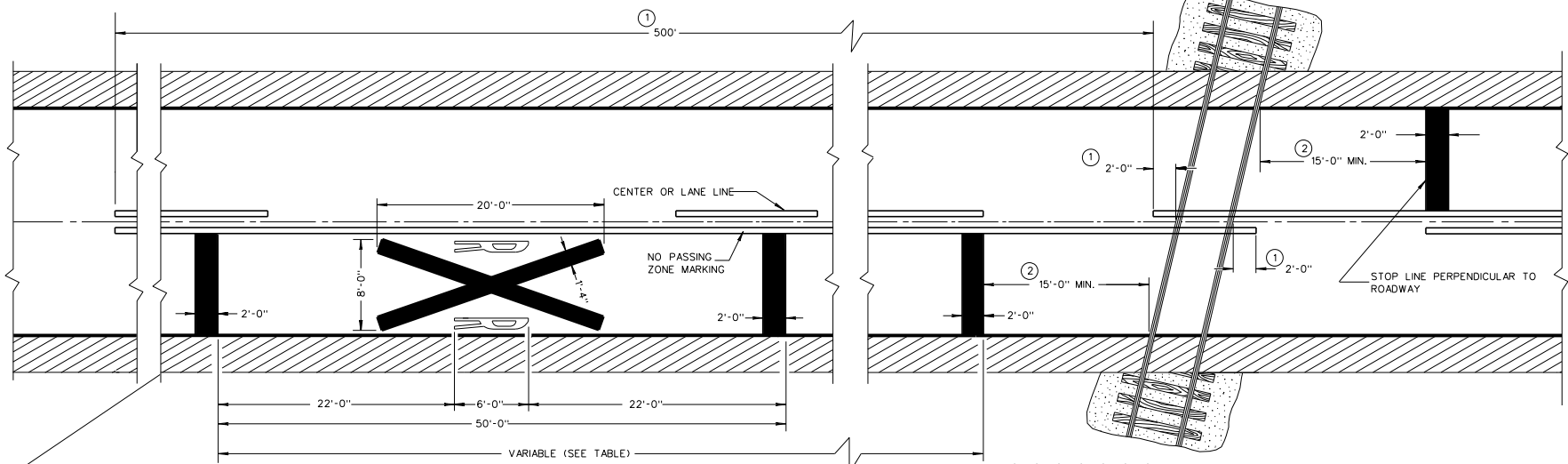

ALTERNATE PAVEMENT MARKING

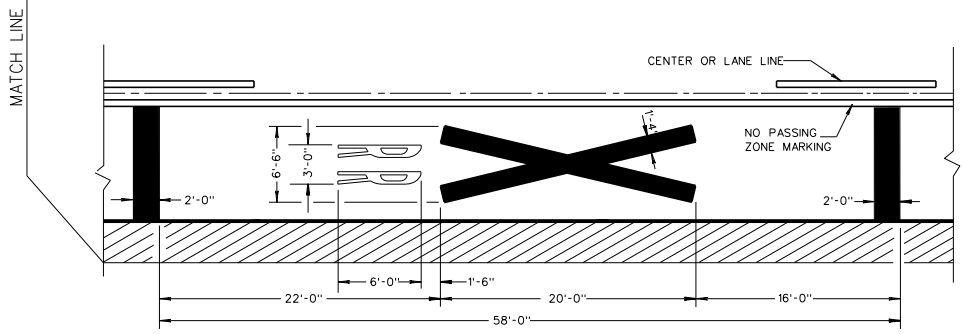

PREFERRED PAVEMENT MARKING

Posted Speed (M.P.H.)	Variable Dimension (Feet)
25	150
30	200
35	250
40	300
45	400
50	550
55	750

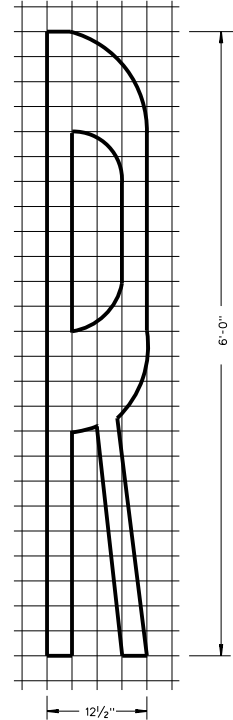

GENERAL NOTES

DETAILS OF CONSTRUCTION, MATERIALS, AND WORKMANSHIP NOT SHOWN ON THIS DRAWING SHALL CONFORM TO THE PERTINENT REQUIREMENTS OF THE STANDARD SPECIFICATIONS AND THE APPLICABLE SPECIAL PROVISIONS.

THE DISTANCE FROM THE RAILROAD CROSSING MARKING TO THE NEAREST TRACK WILL VARY ACCORDING TO THE APPROACH SPEED AND THE SIGHT DISTANCE OF THE VEHICULAR TRAFFIC. DIMENSIONS SHOWN IN THE TABLE SHALL BE USED UNLESS OTHERWISE SHOWN ON THE PLANS.

A THREE-LANE ROADWAY SHOULD BE MARKED WITH A CENTERLINE FOR TWO-LANE APPROACH OPERATION ON THE APPROACH TO A CROSSING.

ON MULTI-LANE ROADS THE TRANSVERSE BANDS SHOULD EXTEND ACROSS ALL APPROACH LANES, AND INDIVIDUAL R X R SYMBOLS SHOULD BE USED IN EACH APPROACH LANE. ALL LETTERS AND SYMBOLS SHALL BE IN CONFORMANCE WITH THE "STANDARD ALPHABETS FOR HIGHWAY SIGNS AND PAVEMENT MARKINGS" (ADOPTED BY THE FEDERAL HIGHWAY ADMINISTRATION).

TRANSVERSE BANDS AND R X R SYMBOL ARE REFLECTIVE WHITE. SOLID LONGITUDINAL LINE IS REFLECTIVE YELLOW ON BIDIRECTIONAL TRAVELED WAYS AND IS OMITTED ON UNIDIRECTIONAL TRAVELED WAYS. DASHED LONGITUDINAL LINE IS REFLECTIVE YELLOW WHEN IT IS BETWEEN LANES OF TRAFFIC MOVING IN OPPOSITE DIRECTIONS AND REFLECTIVE WHITE WHEN IT IS BETWEEN LANES OF TRAFFIC MOVING IN THE SAME DIRECTION.

CENTER OR LANE LINES AND NO PASSING ZONE MARKINGS SHOWN ON THIS DRAWING ARE REQUIRED AND PAID FOR UNDER OTHER ITEMS IN THE CONTRACT.

- ① MARKING LIMITS MAY BE EXTENDED AS DIRECTED BY THE ENGINEER TO MEET ADJACENT NO PASSING ZONE MARKINGS.
- ② MINIMUM 8' TO GATE IF PRESENT.

PAVEMENT MARKING DETAILS FOR RAILROAD-HIGHWAY GRADE CROSSINGS	
STATE OF WISCONSIN DEPARTMENT OF TRANSPORTATION	
APPROVED 11/29/00 DATE	DETAIL DRAWING = 6.40A
FHWA	

SECTION E: BIDDERS ACKNOWLEDGEMENT

**2024 SEMI-PERMANENT EPOXY PAVEMENT MARKINGS
CONTRACT NO. 9495**

Bidder must state a Unit Price and Total Bid for each item. The Total Bid for each item must be the product of quantity, by Unit Price. The Grand Total must be the sum of the Total Bids for the various items. In case of multiplication errors or addition errors, the Grand Total with corrected multiplication and/or addition shall determine the Grand Total bid for each contract. The Unit Price and Total Bid must be entered numerically in the spaces provided. All words and numbers shall be written in ink.

1. The undersigned having familiarized himself/herself with the Contract documents, including Advertisement for Bids, Instructions to Bidders, Form of Proposal, City of Madison Standard Specifications for Public Works Construction - 2024 Edition thereto, Form of Agreement, Form of Bond, and Addenda issued and attached to the plans and specifications on file in the office of the City Engineer, hereby proposes to provide and furnish all the labor, materials, tools, and expendable equipment necessary to perform and complete in a workmanlike manner the specified construction on this project for the City of Madison; all in accordance with the plans and specifications as prepared by the City Engineer, including Addenda Nos. _____ through _____ to the Contract, at the prices for said work as contained in this proposal. (Electronic bids submittals shall acknowledge addendum under Section E and shall not acknowledge here)
2. If awarded the Contract, we will initiate action within seven (7) days after notification or in accordance with the date specified in the contract to begin work and will proceed with diligence to bring the project to full completion within the number of work days allowed in the Contract or by the calendar date stated in the Contract.
3. The undersigned Bidder or Contractor certifies that he/she is not a party to any contract, combination in form of trust or otherwise, or conspiracy in restraint of trade or commerce or any other violation of the anti-trust laws of the State of Wisconsin or of the United States, with respect to this bid or contract or otherwise.
4. I hereby certify that I have met the Bid Bond Requirements as specified in Section 102.5.
(IF BID BOND IS USED, IT SHALL BE SUBMITTED ON THE FORMS PROVIDED BY THE CITY. FAILURE TO DO SO MAY RESULT IN REJECTION OF THE BID).
5. I hereby certify that all statements herein are made on behalf of _____ (name of corporation, partnership, or person submitting bid) a corporation organized and existing under the laws of the State of _____ a partnership consisting of _____; an individual trading as _____; of the City of _____ State of _____; that I have examined and carefully prepared this Proposal, from the plans and specifications and have checked the same in detail before submitting this Proposal; that I have fully authority to make such statements and submit this Proposal in (its, their) behalf; and that the said statements are true and correct.

SIGNATURE

TITLE, IF ANY

Sworn and subscribed to before me this _____ day of _____, 20_____.

(Notary Public or other officer authorized to administer oaths)
My Commission Expires _____

Bidders shall not add any conditions or qualifying statements to this Proposal.

SECTION F: BEST VALUE CONTRACTING
2024 SEMI-PERMANENT EPOXY PAVEMENT MARKINGS
CONTRACT NO. 9495

Best Value Contracting

1. The Contractor shall indicate the non-apprenticeable trades used on this contract.

2. Madison General Ordinance (M.G.O.), 33.07(7), does provide for some exemptions from the active apprentice requirement. Apprenticeable trades are those trades considered apprenticeable by the State of Wisconsin. Please check applicable box if you are seeking an exemption.

- Contractor has a total skilled workforce of four or less individuals in all apprenticeable trades combined.
- No available trade training program; The Contractor has been rejected by the only available trade training program, or there is no trade training program within 90 miles.
- Contractor is not using an apprentice due to having a journey worker on layoff status, provided the journey worker was employed by the contractor in the past six months.
- First-time Contractor on City of Madison Public Works contract requests a onetime exemption but intends to comply on all future contracts and is taking steps typical of a "good faith" effort.
- Contractor has been in business less than one year.
- Contractor doesn't have enough journeyman trade workers to qualify for a trade training program in that respective trade.
- An exemption is granted in accordance with a time period of a "Documented Depression" as defined by the State of Wisconsin.

3. The Contractor shall indicate on the following section which apprenticeable trades are to be used on this contract. Compliance with active apprenticeship, to the extent required by M.G.O. 33.07(7), shall be satisfied by documentation from an applicable trade training body; an apprenticeship contract with the Wisconsin Department of Workforce Development or a similar agency in another state; or the U.S Department of Labor. This documentation is required prior to the Contractor beginning work on the project site.

- The Contractor has reviewed the list and shall not use any apprenticeable trades on this project.

LIST APPRENTICABLE TRADES (check all that apply to your work to be performed on this contract)

- BRICKLAYER
- CARPENTER
- CEMENT MASON / CONCRETE FINISHER
- CEMENT MASON (HEAVY HIGHWAY)
- CONSTRUCTION CRAFT LABORER
- DATA COMMUNICATION INSTALLER
- ELECTRICIAN
- ENVIRONMENTAL SYSTEMS TECHNICIAN / HVAC SERVICE TECH/HVAC INSTALL / SERVICE
- GLAZIER
- HEAVY EQUIPMENT OPERATOR / OPERATING ENGINEER
- INSULATION WORKER (HEAT & FROST)
- IRON WORKER
- IRON WORKER (ASSEMBLER, METAL BLDGS)
- PAINTER & DECORATOR
- PLASTERER
- PLUMBER
- RESIDENTIAL ELECTRICIAN
- ROOFER & WATER PROOFER
- SHEET METAL WORKER
- SPRINKLER FITTER
- STEAMFITTER
- STEAMFITTER (REFRIGERATION)
- STEAMFITTER (SERVICE)
- TAPER & FINISHER
- TELECOMMUNICATIONS (VOICE, DATA & VIDEO) INSTALLER-TECHNICIAN
- TILE SETTER

SECTION G: BID BOND

LET ALL KNOW BY THESE DOCUMENTS PRESENTED, THAT Principal and Surety, as identified below, are held and firmly bound unto the City of Madison, (hereinafter referred to as the "Obligee"), in the sum of five per cent (5%) of the amount of the total bid or bids of the Principal herein accepted by the Obligee, for the payment of which the Principal and the Surety bind themselves, their heirs, executors, administrators, successors and assigns, jointly and severally, firmly by these presents.

The conditions of this obligation are such that, whereas the Principal has submitted, to the City of Madison a certain bid, including the related alternate, and substitute bids attached hereto and hereby made a part hereof, to enter into a contract in writing for the construction of:

2024 SEMI-PERMANENT EPOXY PAVEMENT MARKINGS CONTRACT NO. 9495

1. If said bid is rejected by the Obligee, then this obligation shall be void.
2. If said bid is accepted by the Obligee and the Principal shall execute and deliver a contract in the form specified by the Obligee (properly completed in accordance with said bid) and shall furnish a bond for his/her faithful performance of said contract, and for the payment of all persons performing labor or furnishing materials in connection therewith, and shall in all other respects perform the agreement created by the acceptance of said bid, then this obligation shall be void.

If said bid is accepted by the Obligee and the Principal shall fail to execute and deliver the contract and the performance and payment bond noted in 2. above executed by this Surety, or other Surety approved by the City of Madison, all within the time specified or any extension thereof, the Principal and Surety agree jointly and severally to forfeit to the Obligee as liquidated damages the sum mentioned above, it being understood that the liability of the Surety for any and all claims hereunder shall in no event exceed the sum of this obligation as stated, and it is further understood that the Principal and Surety reserve the right to recover from the Obligee that portion of the forfeited sum which exceed the actual liquidated damages incurred by the Obligee.

The Surety, for value received, hereby stipulates and agrees that the obligations of said Surety and its bond shall be in no way impaired or affected by an extension of the time within which the Obligee may accept such bid, and said Surety does hereby waive notice of any such extension.

IN WITNESS WHEREOF, the Principal and the Surety have hereunto set their hands and seals, and such of them as are corporations have caused their corporate seals to be hereto affixed and these presents to be signed by their proper officers, on the day and year set forth below.

Seal PRINCIPAL

Name of Principal

By

Date

Name and Title

Seal SURETY

Name of Surety

By

Date

Name and Title

This certifies that I have been duly licensed as an agent for the above company in Wisconsin under National Provider No. _____ for the year _____, and appointed as attorney in fact with authority to execute this bid bond and the payment and performance bond referred to above, which power of attorney has not been revoked.

Date

Agent Signature

Address

City, State and Zip Code

Telephone Number

NOTE TO SURETY & PRINCIPAL

The bid submitted which this bond guarantees shall be rejected if the following instrument is not attached to this bond:

Power of Attorney showing that the agent of Surety is currently authorized to execute bonds on behalf of the Surety, and in the amounts referenced above.

Certificate of Biennial Bid Bond

TIME PERIOD - VALID (FROM/TO)
NAME OF SURETY
NAME OF CONTRACTOR
CERTIFICATE HOLDER <p style="text-align: center;">City of Madison, Wisconsin</p>

This is to certify that a biennial bid bond issued by the above-named Surety is currently on file with the City of Madison.

This certificate is issued as a matter of information and conveys no rights upon the certificate holder and does not amend, extend or alter the coverage of the biennial bid bond.

Cancellation: Should the above policy be cancelled before the expiration date, the issuing Surety will give thirty (30) days written notice to the certificate holder indicated above.

Signature of Authorized Contractor Representative

Date

SECTION H: AGREEMENT

THIS AGREEMENT made this _____ day of _____ in the year Two Thousand and _____ between _____ hereinafter called the Contractor, and the City of Madison, a Wisconsin municipal corporation, hereinafter called the City.

WHEREAS, the Common Council of the City of Madison ("Council") under the provisions of a resolution adopted on _____, and by virtue of authority vested in the Council, has awarded to the Contractor the work of performing certain public construction.

NOW, THEREFORE, the Contractor and the City, for the consideration hereinafter named, agree as follows:

1. **Scope of Work.** The Contractor shall, perform the construction, execution and completion of the following listed complete work or improvement in full compliance with the Plans, Specifications, Standard Specifications, Supplemental Specifications, Special Provisions and Agreement; perform all items of work covered or stipulated in the Proposal; perform all altered or extra work; and shall furnish, unless otherwise provided in the contract, all materials, implements, machinery, equipment, tools, supplies, transportation, and labor necessary to the prosecution and completion of the work or improvements:

2024 SEMI-PERMANENT EPOXY PAVEMENT MARKINGS CONTRACT NO. 9495

2. **Completion Date/Contract Time.** Construction work must begin within seven (7) calendar days after the date appearing on mailed written notice to do so shall have been sent to the Contractor and shall be carried on at a rate so as to secure full completion SEE SPECIAL PROVISIONS, the rate of progress and the time of completion being essential conditions of this Agreement.
3. **Contract Price.** The City shall pay to the Contractor at the times, in the manner and on the conditions set forth in said specifications, the sum of _____ (\$ _____) Dollars being the amount bid by such Contractor and which was awarded as provided by law.
4. **A. Non-Discrimination.** During the term of this Agreement, the Contractor agrees not to discriminate against any employee or applicant because of race, religion, marital status, age, color, sex, disability, national origin or ancestry, income level or source of income, arrest record or conviction record, less than honorable discharge, physical appearance, sexual orientation, gender identity, political beliefs, or student status. The Contractor further agrees not to discriminate against any subcontractor or person who offers to subcontract on this contract because of race, religion, color, age, disability, sex, sexual orientation, gender identity or national origin.
B. Affirmative Action. The Contractor agrees that within thirty (30) days after the effective date of this agreement, the Contractor will provide to the City Affirmative Action Division certain workforce utilization statistics, using a form to be furnished by the City.

If the contract is still in effect, or if the City enters into a new agreement with the Contractor, within one year after the date on which the form was required to be provided, the Contractor will provide updated workforce information using a second form, also to be furnished by the City. The second form will be submitted to the City Affirmative Action Division no later than one year after the date on which the first form was required to be provided.

The Contractor further agrees that, for at least twelve (12) months after the effective date of this contract, it will notify the City Affirmative Action Division of each of its job openings at facilities in Dane County for which applicants not already employees of the Contractor are to be considered. The notice will include a job description, classification, qualifications and application procedures and deadlines, shall be provided to the City by the opening date of advertisement and with

sufficient time for the City to notify candidates and make a timely referral. The Contractor agrees to interview and consider candidates referred by the Affirmative Action Division, or an organization designated by the Division, if the candidate meets the minimum qualification standards established by the Contractor, and if the referral is timely. A referral is timely if it is received by the Contractor on or before the date started in the notice.

Articles of Agreement Article I

The Contractor shall take affirmative action in accordance with the provisions of this contract to insure that applicants are employed, and that employees are treated during employment without regard to race, religion, color, age, marital status, disability, sex, sexual orientation, gender identity or national origin and that the employer shall provide harassment free work environment for the realization of the potential of each employee. Such action shall include, but not be limited to, the following: employment, upgrading, demotion or transfer, recruitment or recruitment advertising, layoff or termination, rates of pay or other forms of compensation and selection for training including apprenticeship insofar as it is within the control of the Contractor. The Contractor agrees to post in conspicuous places available to employees and applicants notices to be provided by the City setting out the provisions of the nondiscrimination clauses in this contract.

Article II

The Contractor shall in all solicitations or advertisements for employees placed by or on behalf of the Contractors state that all qualified or qualifiable applicants will be employed without regard to race, religion, color, age, marital status, disability, sex, sexual orientation, gender identity or national origin.

Article III

The Contractor shall send to each labor union or representative of workers with which it has a collective bargaining agreement or other contract or understanding a notice to be provided by the City advising the labor union or worker's representative of the Contractor's equal employment opportunity and affirmative action commitments. Such notices shall be posted in conspicuous places available to employees and applicants for employment.

Article V

The Contractor agrees that it will comply with all provisions of the Affirmative Action Ordinance of the City of Madison, including the contract compliance requirements. The Contractor agrees to submit the model affirmative action plan for public works contractors in a form approved by the Affirmative Action Division Manager.

Article VI

The Contractor will maintain records as required by Section 39.02(9)(f) of the Madison General Ordinances and will provide the City Affirmative Action Division with access to such records and to persons who have relevant and necessary information, as provided in Section 39.02(9)(f). The City agrees to keep all such records confidential, except to the extent that public inspection is required by law.

Article VII

In the event of the Contractor's or subcontractor's failure to comply with the Equal Employment Opportunity and Affirmative Action Provisions of this contract or Section 39.03 and 39.02 of the Madison General Ordinances, it is agreed that the City at its option may do any or all of the following:

1. Cancel, terminate or suspend this Contract in whole or in part.
2. Declare the Contractor ineligible for further City contracts until the Affirmative Action requirements are met.
3. Recover on behalf of the City from the prime Contractor 0.5 percent of the contract award price for each week that such party fails or refuses to comply, in the nature of liquidated damages, but not to exceed a total of five percent (5%) of the contract price, or ten thousand dollars (\$10,000), whichever is less. Under public works contracts, if a subcontractor is in noncompliance, the City may recover liquidated damages from the prime Contractor in the manner described above. The preceding sentence shall not be construed to prohibit a prime Contractor from recovering the amount of such damage from the non-complying subcontractor.

Article VIII

The Contractor shall include the above provisions of this contract in every subcontract so that such provisions will be binding upon each subcontractor. The Contractor shall take such action with respect to any subcontractor as necessary to enforce such provisions, including sanctions provided for noncompliance.

Article IX

The Contractor shall allow the maximum feasible opportunity to small business enterprises to compete for any subcontracts entered into pursuant to this contract. (In federally funded contracts the terms "DBE, MBE and WBE" shall be substituted for the term "small business" in this Article.)

5. **Substance Abuse Prevention Program Required.** Prior to commencing work on the Contract, the Contractor, and any Subcontractor, shall have in place a written program for the prevention of substance abuse among its employees as required under Wis. Stat. Sec. 103.503.
6. **Contractor Hiring Practices.**

Ban the Box - Arrest and Criminal Background Checks. (Sec. 39.08, MGO)

This provision applies to all prime contractors on contracts entered into on or after January 1, 2016, and all subcontractors who are required to meet prequalification requirements under MGO 33.07(7)(l), MGO as of the first time they seek or renew pre-qualification status on or after January 1, 2016. The City will monitor compliance of subcontractors through the pre-qualification process.

- a. **Definitions.** For purposes of this section, "Arrest and Conviction Record" includes, but is not limited to, information indicating that a person has been questioned, apprehended, taken into custody or detention, held for investigation, arrested, charged with, indicted or tried for any felony, misdemeanor or other offense pursuant to any law enforcement or military authority.

"Conviction record" includes, but is not limited to, information indicating that a person has been convicted of a felony, misdemeanor or other offense, placed on probation, fined, imprisoned or paroled pursuant to any law enforcement or military authority.

"Background Check" means the process of checking an applicant's arrest and conviction record, through any means.

- b. **Requirements.** For the duration of this Contract, the Contractor shall:

1. Remove from all job application forms any questions, check boxes, or other inquiries regarding an applicant's arrest and conviction record, as defined herein.
2. Refrain from asking an applicant in any manner about their arrest or conviction record until after conditional offer of employment is made to the applicant in question.
3. Refrain from conducting a formal or informal background check or making any other inquiry using any privately or publicly available means of obtaining the arrest or conviction record of an applicant until after a conditional offer of employment is made to the applicant in question.
4. Make information about this ordinance available to applicants and existing employees, and post notices in prominent locations at the workplace with information about the ordinance and complaint procedure using language provided by the City.
5. Comply with all other provisions of Sec. 39.08, MGO.

c. Exemptions: This section shall not apply when:

1. Hiring for a position where certain convictions or violations are a bar to employment in that position under applicable law, or
2. Hiring a position for which information about criminal or arrest record, or a background check is required by law to be performed at a time or in a manner that would otherwise be prohibited by this ordinance, including a licensed trade or profession where the licensing authority explicitly authorizes or requires the inquiry in question.

To be exempt, Contractor has the burden of demonstrating that there is an applicable law or regulation that requires the hiring practice in question, if so, the contractor is exempt from all of the requirements of this ordinance for the position(s) in question.

7. **Choice of Law and Forum Selection.** This Contract shall be governed by and construed, interpreted and enforced in accordance with the laws of the State of Wisconsin. The parties agree, for any claim or suit or other dispute relating to this Contract that cannot be mutually resolved, the venue shall be a court of competent jurisdiction within the State of Wisconsin and the parties agree to submit themselves to the jurisdiction of said court, to the exclusion of any other judicial district that may have jurisdiction over such a dispute according to any law.
8. **Counterparts, Electronic Signature and Delivery.** This Contract may be signed in counterparts, each of which shall be taken together as a whole to comprise a single document. Signatures on this Contract may be exchanged between the parties by facsimile, electronic scanned copy (.pdf) or similar technology and shall be as valid as original; and this Contract may be converted into electronic format and signed or given effect with one or more electronic signature(s) if the electronic signature(s) meets all requirements of Wis. Stat. ch. 137 or other applicable Wisconsin or Federal law. Executed copies or counterparts of this Contract may be delivered by facsimile or email and upon receipt will be deemed original and binding upon the parties hereto, whether or not a hard copy is also delivered. Copies of this Contract, fully executed, shall be as valid as an original.

**2024 SEMI-PERMANENT EPOXY PAVEMENT MARKINGS
CONTRACT NO. 9495**

IN WITNESS WHEREOF, the Contractor has hereunto set his/her hand and seal and the City has caused this contract to be executed by its Mayor and City Clerk on the dates written below.

Countersigned:

Company Name

Witness

Date

President

Date

Witness

Date

Secretary

Date

CITY OF MADISON

Satya Rhodes-Conway, Mayor

Date

Maribeth Witzel-Behl, City Clerk

Date

Provisions have been made to pay the liability that will accrue under this contract.

David P. Schmiedicke, Finance Director

Date

Approved as to form:

Michael Haas, City Attorney

Date

Execution of this Agreement by City was authorized by Resolution Enactment No. RES - _____, ID No. _____, adopted by the Common Council of the City of Madison on _____, 20__.

SECTION I: PAYMENT AND PERFORMANCE BOND

LET ALL KNOW BY THESE DOCUMENTS PRESENTED, that we _____
as principal, and _____
Company of _____ as surety, are held and firmly bound unto the City of
Madison, Wisconsin, in the sum of _____ (\$_____) Dollars, lawful money of the United
States, for the payment of which sum to the City of Madison, we hereby bind ourselves and our
respective executors and administrators firmly by these presents.

The condition of this Bond is such that if the above bounden shall on his/her part fully and faithfully
perform all of the terms of the Contract entered into between him/herself and the City of Madison for the
construction of:

**2024 SEMI-PERMANENT EPOXY PAVEMENT MARKINGS
CONTRACT NO. 9495**

in Madison, Wisconsin, and shall pay all claims for labor performed and material furnished in the
prosecution of said work, and save the City harmless from all claims for damages because of negligence
in the prosecution of said work, and shall save harmless the said City from all claims for compensation
(under Chapter 102, Wisconsin Statutes) of employees and employees of subcontractor, then this Bond is
to be void, otherwise of full force, virtue and effect.

Signed and sealed this _____ day of _____

Countersigned:

Company Name (Principal)

Witness

President Seal

Secretary

Surety Seal
 Salary Employee Commission

By _____
Attorney-in-Fact

This certifies that I have been duly licensed as an agent for the above company in Wisconsin under
National Producer Number _____ for the year _____, and appointed as attorney-in-fact
with authority to execute this payment and performance bond which power of attorney has not been
revoked.

Date

Agent Signature

The foregoing Bond has been approved as to form:

Date

City Attorney